

Challenger® 3 AL5900



IP66

Benefits

- The optically precise, symmetrical beam of the Challenger® 3 is specifically designed for stadium floodlighting

Options

- Half-concentric louvre (AL5921) or single blade visor (AL5922) to reduce light pollution. Gun sight aiming kit, incorporating gun sight and bracket (AL5931)
- A hot restrick option is available, complete with electronic ignitor. Compatible with standard control gear types. Contact our sales office for further details

Technical features

- Body made from high pressure die-cast aluminium, coated in light grey (RAL 7035) polyester powder
- Reflector system made from high-purity, polished and anodised aluminium. Incorporates an internal baffle to improve efficiency and reduce glare
- Toughened front glass, secured by cast aluminium front frame
- Galvanised steel stirrup, with additional elevation locking screws
- Electrical connection box (IP66) housing an ignitor is located on the side of the stirrup and fitted with two Gore™ membrane breathers
- Designed to accept double-ended, short-arc 2kW or 1kW metal halide lamps
- To ensure the beam can be accurately aligned, there is dual provision for a gun sight aiming device on the side of the floodlight body (AL5931)
- Rear cover gives easy access for re-lamping, with a stainless steel catch for positive closure

Beam type	Lamp Manufacturer product code	Lamp manufacturer	Lamp: Abacus product code	Lampholder type
AL5901	2kW: HQI-TS 2000WDS	Oslram	LPW2000M/D	K12s-7 cable
AL5902	2kW: HQI-TS 2000WDS	Oslram	LPW2000M/D	K12s-7 cable
AL5903	2kW: HQI-TS 2000WDS	Oslram	LPW2000M/D	K12s-7 cable
AL5904	1kW: HQI-TS 1000WDS	Oslram	LPW1000M/B/L	K12s-7 cable
AL5905	1kW: HQI-TS 1000WDS	Oslram	LPW1000M/B/L	K12s-7 cable
AL5906	1kW: HQI-TS 1000WDS	Oslram	LPW1000M/B/L	K12s-7 cable
AL5907	MHN-SA 2kW 400V/956	Philips	LPP200MHN-SA	XW UNP
AL5908	MHN-SA 2kW 400V/956	Philips	LPP200MHN-SA	XW UNP
AL5909	MHN-SA 2kW 400V/956	Philips	LPP200MHN-SA	XW UNP
AL5910	MHN-SA 2kW 400V/956	Philips	LPP200MHN-SA	XW UNP
AL5911	MHN-SB 2kW 400V/956	Philips	LPP200MHN-SB	K12s-7 WH UNP
AL5912	MHN-SB 2kW 400V/956	Philips	LPP200MHN-SB	K12s-7 WH UNP
AL5913	MHN-SB 2kW 400V/956	Philips	LPP200MHN-SB	K12s-7 WH UNP
AL5914	MHN-SB 2kW 400V/956	Philips	LPP200MHN-SB	K12s-7 WH UNP

Lamp references

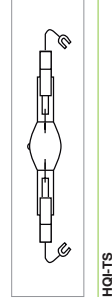
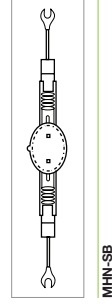
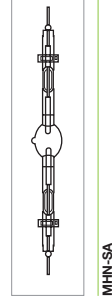

Dimensions (mm)

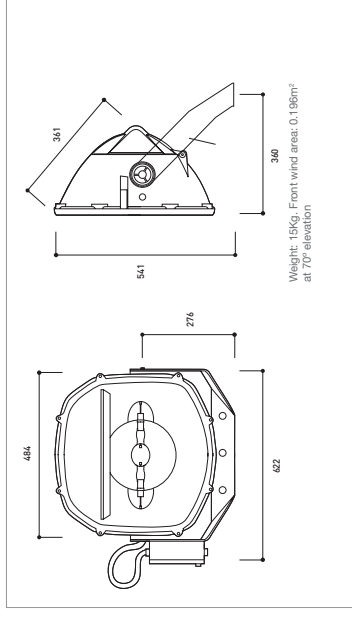

Maintenance

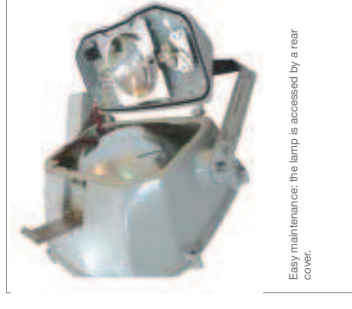

Accessories



Single blade louvre – AL5922

This accessory has been designed for the Challenger® 2 & 3 to minimise upward glare while maintaining good vertical lighting levels on the playing field

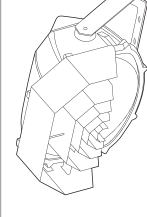

Half concentric louvre – AL5921

This Challenger® 3 accessory provides the greatest control of upward light and overspill

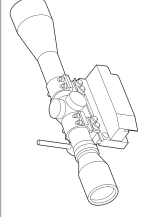

Aiming tool kit – AL5931

Set of equipment and instructions to help aim the Challenger® 2 & 3 with pinpoint accuracy. This gives the highest possible level of aiming control during the commissioning stage of any floodlighting project



Key features

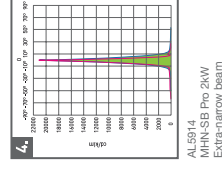
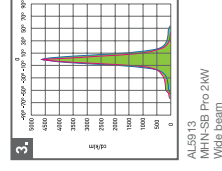
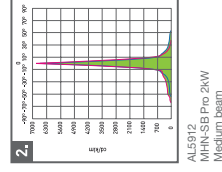
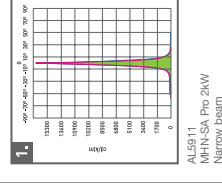

Technical information may alter dependent on control gear used

*Measured on a 10.3A ballast.